



INSTALLATION & OPERATION MANUAL

Before operating this product, please read the instructions carefully and save this manual for future use.

TEDIBP52SV1



1 HEAT / 1 COOL SINGLE STAGE THERMOSTAT
5+2 PROGRAMMABLE, COMPATIBLE WITH HEAT PUMP SYSTEM



**SINGLE STAGE
PROGRAMMABLE THERMOSTAT**

TEDIBP52SV1

CONTENT

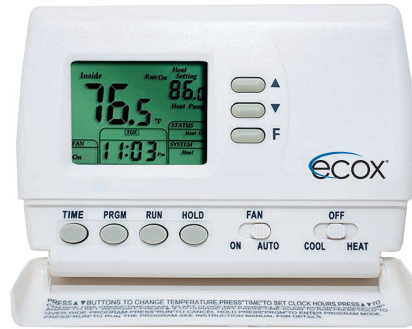

- 2** SPECIFICATION / FEATURES / SAFETY
- 3** REMOVE THE OLD THERMOSTAT / INSTALL THE THERMOSTAT
- 4** FAN OPTION SWITCH / BATTERY OPERATION
- 5** WIRING DIAGRAMS
- 6** CHECK THERMOSTAT OPERATION / REPLACING BATTERIES
- 7** CONFIGURATION & OPERATION
- 9** THERMOSTAT OPERATION / MANUAL OPERATION
- 10** PLANING YOUR PROGRAM
- 11** SETTING PROGRAM / ENTER YOUR HEATING & COOLING PROGRAM
- 12** REVERT TO FACTORY DEFAULT PROGRAM SETTINGS /
THERMOSTAT BUTTONS & SWITCHES
- 13** THERMOSTAT LCD DISPLAY
- 14** TROUBLESHOOTING
- 15** WARANTY POLICY

READ THIS MANUAL

Inside you will find many helpful hints on how to use and maintain your air conditioner properly. Just a little preventative care on your part can save you a great deal of time and money over the life of your air conditioner. You'll find many answers to common problems in the chart of troubleshooting tips. If you review the chart of Troubleshooting Tips first, you may not need to call for service

SPECIFICATION:

Power Supply:	20VAC-30VAC 50-60HZ or Battery powered.
Terminal Load:	1.0A per terminal, 3.0A maximum total load
Set Point Temperature Range:	45°F to 90°F (7°C to 32°C).
Accuracy:	+/- 1°F or +/- 0.5°C.
Dimensions:	5.1" WX 3.7" H X 1.2" D / 12,9cm W x 9,4cm H x 3cm D
Color:	White

FEATURES:

- Separate 5-day (weekday) and 2-day (Saturday/Sunday) programming with four separate time/temperature periods per day.
- Large LCD display with backlight, continuous backlight option.
- Simultaneous heat and cool set point storage.
- Display of room temperature and current time simultaneously.
- Fan switch with **ON** and **AUTO**.
- Permanent user setting retention during power loss. No batteries are required.
- Operates from 24VAC, or from 2 size "AAA" alkaline batteries.
- Optional temperature display of Fahrenheit or Celsius scale.
- Air Filter change indicator.
- Low Battery indicator.
- Display temperature calibration.
- Intelligent Recovery Option for optimizing comfort.



IMPORTANT SAFETY INFORMATION:

- Always turn off power at the main power source by removing the fuse, or switching the circuit breaker to the off position before installing, removing, cleaning, or servicing this thermostat.
- Read all of the information in this manual before installing this thermostat.
- Use a professional contractor to install this thermostat.
- This is a 24 VAC low-voltage thermostat.
- **DO NOT INSTALL ON VOLTAGES HIGHER THAN 30 VAC.**
- ALL wiring must conform to local and national building and electrical codes and ordinances.
- Do not short (jumper) across terminals on the gas valve or at the system control to test installation. This will damage the thermostat and void the warranty.
- Do not switch the system to cool if the temperature is below 50°F (10°C). This can damage the air conditioning system and may cause personal injury.
- Replace batteries when the battery icon indicates the low battery message.
- Change the Air Filter when the Filter Change icon begins blinking.
- Use this thermostat only as described in this manual.



REMOVE THE OLD THERMOSTAT

WARNING! : Electrical Shock Hazard

- 1 Turn off power at the main service panel by removing the fuse or switching the appropriate circuit breaker to the OFF position before removing the existing thermostat.
- 2 Turn off power to the heating and cooling system by removing the fuse or switching the appropriate circuit breaker OFF.
- 3 Remove the cover of the old thermostat. This should expose the wires.
- 4 Label the existing wires from the existing thermostat before removing.
- 5 After labeling the wires, remove the wires from the wire terminals.
- 6 Remove the existing thermostat from the wall.
- 7 Refer to the following section for instructions on how to install this thermostat.

INSTALL THE THERMOSTAT

ATTACH THERMOSTAT BASE TO WALL

PULL THE COVER OFF THE BASE.

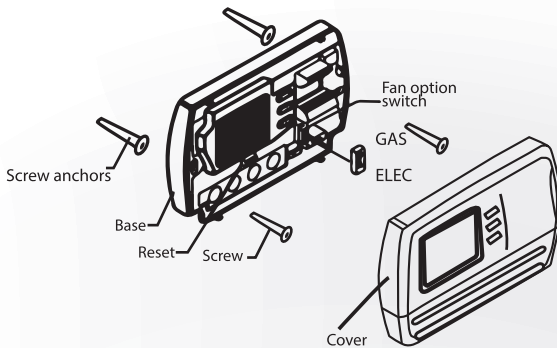

FIGURE 1

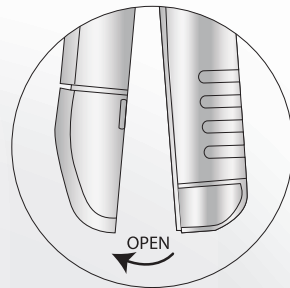

FIGURE 2



WARNING! : Electrical Shock Hazard

Turn off power at the main service panel by removing the fuse or switching the appropriate circuit breaker to the OFF position before removing the existing thermostat.

- 1** Turn off power to the heating and cooling system by removing the fuse or switching the appropriate circuit breaker off.
- 2** Place the system switch (**COOL/OFF/HEAT**) in the **OFF** position.
- 3** Place the FAN (**AUTO/ON**) switch in the **AUTO** position.
- 4** Gently pull the cover straight off the base. (See figure 2.)
- 5** Put the thermostat base against the wall where you plan to mount it (Be sure the wires will feed through the wire opening in the base of the thermostat.)
- 6** Mark the placement of the mounting holes.
- 7** Move the base out of the way. Drill mounting holes. Use a hammer to tap in the supplied anchors into the mounting holes.
- 8** Fasten the base loosely to the wall as shown in **Figure 1**, using two mounting screws. Place a level against the bottom of the base and adjust until level, then tighten the screws. (Leveling is for appearance only, and will not affect thermostat operation.)
- 9** Insert stripped, labeled wires into matching wire terminals. See "**Wiring Diagrams**", **Section 3, Figure 3**.
CAUTION: Be sure exposed portions of wires do not touch other wires.
- 10** Tighten screws on terminal block. Gently tug on each wire to be sure of proper connection. Double check that each wire is connected to the proper terminal.
CAUTION: Installing batteries backwards can damage the thermostat.
- 11** Install two fresh "AAA" alkaline batteries in the battery compartment. Be sure to match positive (+) ends of batteries with positive (+) battery terminals in the battery compartment. (The thermostat will operate from 2 size "AAA" alkaline batteries or 24VAC power. When operated from 24VAC power, your thermostat will maintain time and continuously display the temperature during a loss of AC power with the batteries installed.)
- 12** Replace the cover on the thermostat by snapping it in place.
- 13** Turn on power to the system at the main service panel.
- 14** Test thermostat operation as described in the following section.

FAN OPTION SWITCH

Read the following information before setting the fan option switch (See figure 1). If you are unsure of your application, contact a qualified service person.

This thermostat is configured from the factory to energize the fan on a call for heat. If your system is an electric heat or heat pump that **REQUIRES** the thermostat to turn on the fan on a call for heat, place the fan option switch in the **ELEC** position. If your system does not require the thermostat to energize the fan on a call for heat such as fossil fuel (gas, oil, etc.), forced air system as well as hydraulic heating systems, place the fan option switch in the **GAS** position.

BATTERY OPERATION

The thermostat will operate from 2 size "AAA" alkaline batteries or 24VAC power. When operated from batteries, connection to the "C" (common) or (neutral) terminal is not required.

NOTE: When operated from batteries (No "C" terminal connection), the LCD display backlight options are limited to option 1 (disabled) or option 2 (30 second illumination after each button press).

WIRING DIAGRAMS

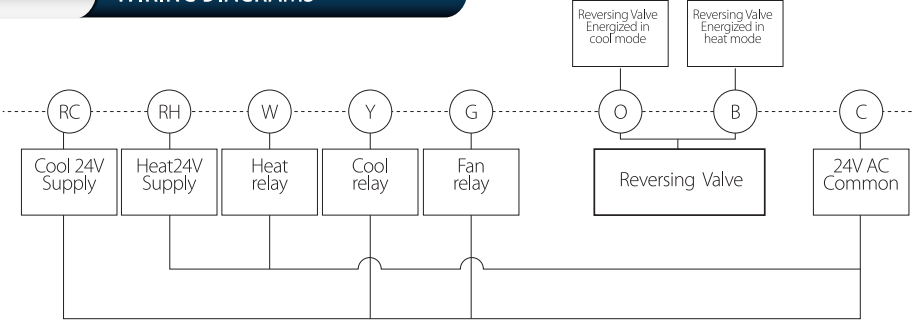

Figure 3, Typical wiring diagram for heat/cool, 5 wire two transformer system.

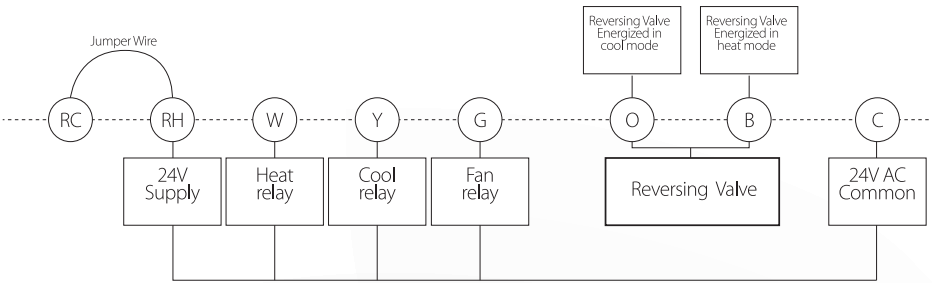
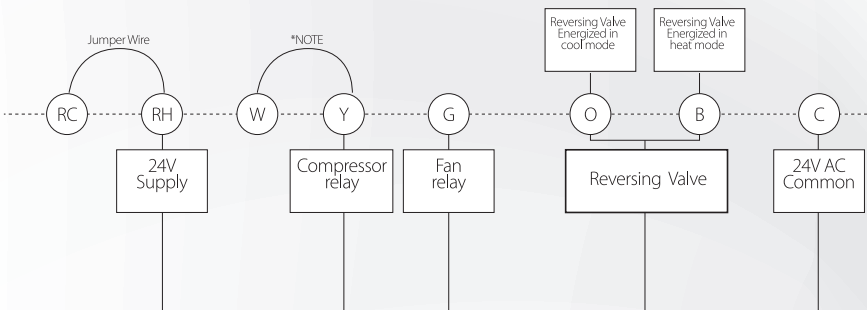

Figure 4, Typical wiring diagram for heat/cool, 4 wire, single transformer system



*Note: Jumper required in heat pump mode.

Figure 5, Typical wiring diagram for heat pump with reversing valve

CHECK THERMOSTAT OPERATION

If at any time during testing your system does not operate properly, contact a qualified service person.

Turn on power to the system.

FAN OPERATION

- 1** Move the system switch to the **OFF** position. If your system does not have a “**G**” (Fan) terminal connection, skip to the Heating System.
- 2** Move the fan switch to the **ON** position. The blower should begin to operate.
- 3** Move the fan switch to the **AUTO** position. The blower should stop immediately.

HEATING SYSTEM

- 1** Move the **SYSTEM** switch to the **HEAT** position. If the auxiliary heating system has a standing pilot, be sure to light it.
- 2** When the (**FA**) fast heating cycle rate is selected in the configuration menu, (see configuration menu item 2), the thermostat will call for heat at 0.5°F (0.5°C) below set-point, and turn off at set point. When the (**SL**) slow heating cycle rate is selected, the thermostat will call for heat at 1.5°F (1.5°C) below set-point, and turn off at set-point. When the thermostat calls for heat, the display will show Heat On. If the Heat On display is flashing, the compressor lockout feature is operating in the heat pump mode. (Note: See Configuration menu item 8).

COOLING SYSTEM

CAUTION: To prevent compressor and/or property damage, if the outdoor temperature is below 50°F (10°C), DO NOT operate the cooling system.

- 1** Move the **SYSTEM** switch to the **COOL** position.
- 2** When the (**FA**) fast cooling cycle rate is selected in the configuration menu, (see configuration menu item 2), the thermostat will call for cooling at 0.5°F (0.5°C) above set-point, and turn off at set point. When the (**SL**) slow cool cycle rate is selected, the thermostat will call for cooling at 1.5°F (1.5°C) above set-point, and turn off at set-point. When the thermostat calls for cooling, the display will show **COOL On**. If the **COOL On** display is flashing, the compressor lockout feature is operating mode. (Note: See Configuration menu item 8)

If all functions operate properly, the thermostat is installed correctly.

REPLACING BATTERIES

If your thermostat was pre-installed, the batteries may be in place. If the battery icon on the display is flashing, it indicates that the batteries need to be replaced.

When the thermostat is powered only by battery, the battery icon will flash for approximately 2 months before the batteries are expected to expire. Then the thermostat will cut power to the heating/cooling system.

Important: Replace the batteries when the low battery message flashes on the display. This will keep the thermostat operating properly. With two "AAA" batteries installed, your thermostat will maintain time and continuously display the temperature during a loss of AC power.

- 1** Place the **COOL/OFF/HEAT** switch in the **OFF** position.
- 2** Pull the **FAN/ AUTO/ON** switch in the **AUTO** position.
- 3** Gently pull the cover straight off the base.
- 4** Install two "AAA" alkaline batteries in the battery compartment. Be sure to match the positive (+) ends of the batteries with the positive terminals marked in the battery compartment.
- 5** It may take as long as 30 seconds for the **Low Battery** icon to disappear after changing batteries.

CAUTION: Incorrect battery installation can damage the thermostat and void the warranty.

CONFIGURATION AND OPERATION

1.CONFIGURATION MENU

The configuration menu allows you to set certain thermostat operating characteristics to your system or personal requirements. Move the **SYSTEM** switch to the **OFF** position, then press and hold the **PRGM** and **RUN** buttons for 3 seconds to enter the configuration menu. The display will show the first item in the configuration menu Press the **PRGM** button to move to the next menu item, or press **TIME** to return to a previous menu item. To revert to factory default settings, press to

RESET button (See fig. 1). All user's changed settings will revert to factory default settings, including program settings. Use the **↑** and **↓** buttons to select. To exit the configuration menu and return to normal operation, press the **RUN** button. If no buttons are pressed within 30 seconds, the thermostat will exit the configuration menu.

The configuration menu chart summaries the configuration options. An explanation of each option follows.

Step	Press Buttons	Displayed (Factory Defaults)	Press ↑ or ↓ to select	Description
1	PRGM + RUN 5 seconds	CC(FA)	FA or SL	Select (FA)st or (SL)ow Cooling Cycles / Default=(FA)
2	PRGM	HC(FA)	FA or SL	Select (FA)st or (SL)ow Heating Cycles / Default=(FA)
3	PRGM	h0 (0)	0 or 1	Select system heating type 0 = Gas, Oil, or electric heating. 1= Heat Pump heating / Default=0
4	PRGM	bl (2)	1-3	Select display backlight (1)=OFF, (2)=30 seconds on any button push, (3)=ON / Default=(2) Option (3) can be activated only if the common is used
5	PRGM	FL (00)	00, 1 thru 12	Select filter time in months. Default=00 A selection of "00" deactivates the filter feature
6	PRGM	FC(F)	F or C	Select Temperature display to indicate °F or °C / Default=F
7	PRGM	CL (0)	+4 to -4	Select temperature calibration point up to 4° higher or 4° lower Default=0
8	PRGM	CP (5)	0-5	Compressor lockout delay. 0=none 5=5 minutes Default = 5
9	PRGM	IC	0-1	Intelligent Recovery Option. "1"= Active 0 = Deactivated. Default = 0
10	RUN			Return to normal operation

1 SELECT COOLING CYCLE RATE

The **FA** setting is used to produce shorter cooling cycles. The **SL** setting produces a longer cooling cycle. Both settings produce very accurate temperature control and can be set to your personal preference. **FA** cycles the system at a 0.5°F (0.5°C) differential, and **SL** cycles the system at 1.5°F (1.5°C).

2 SELECT HEATING CYCLE RATE

The **FA** setting is used to produce shorter heating cycles. The **SL** setting produces a longer heating cycle. Both settings produce very accurate temperature control and can be set to your personal preference. **FA** cycles the system at a 0.5°F (0.5°C) differential, and **SL** cycles the system at 1.5°F (1.5°C).

3 SELECT SYSTEM HEATING TYPE

Users can select the system heating type according to their heating system. Select "0" for gas, oil, or electric heating systems. Select "1" for a heat pump heating system.

4 SELECT DISPLAY BACKLIGHT

The display backlight improves display contrast in low lighting conditions. Select **1** for NO backlight display. Select **2** for the backlight to come on for approximately 30 seconds when any button or the thermostat is touched.



Select **3** for the backlight to remain on continuously.

NOTE: When operated from batteries (No "C" terminal connection), the LCD display backlight options are limited to option **1** (disabled) or option **2** (30 second illumination after each button press).

5 SELECT FILTER REPLACEMENT RUN TIME

The thermostat will display the Filter Alarm after a set time or operation.

This is a reminder to change or clean your air filter. This time can be set from **0** to **12** months in **1** month increments. Selection of **00** WILL CANCEL THIS FEATURE.

When Filter Alarm is displayed, you can clear it by pressing the "F" button. (To enter filter program) and then hold the  and  buttons. This resets the timer and starts counting the days until the next filter change.

6 SELECT °F OR °C READOUT

Changes the display readout to Centigrade or Fahrenheit as required.

7 SELECT TEMPERATURE RECALIBRATION

This feature allows you to adjust the displayed room temperature up to 4° higher or lower. Your thermostat can be accurately calibrated to match your previous thermostat. The current or adjusted room temperature will be displayed on the display.

8 SELECT COMPRESSOR LOCKOUT DELAY

To protect the compressor from short cycling, you can select compressor off-time cycle between 0 or 5 minutes. When the thermostat compressor time delay occurs, the **Cool On** or **Heat On** display will flash during compressor lockout.

9 INTELLIGENT RECOVERY

When selected (1). The thermostat will calculate how long it takes to bring the room temperature up to the programmed set-point on the first set-up period of the day, and activate the system earlier so that the room temperature is at set-point at the set-up time.

THERMOSTAT OPERATION

1 SETTING THE THERMOSTAT

This thermostat is very easy to operate. Set the **SYSTEM** switch to either **HEAT** or **COOL**, then press the **▲** or **▼** buttons until the temperature you want to maintain is shown on the right side of the display. If you want to turn the system off, just move the **SYSTEM** switch to the **OFF** position and the **FAN** switch to the **AUTO** position.

2 SET CURRENT DAY AND TIME

Press the **TIME** button. The hours display will begin to blink.

Press the **▼** or **▲** buttons until you reach the correct hour and **AM/PM** designation (**AM begins at mid-night, and PM begins at noon**)

Press the **TIME** button again. The minutes display will begin to blink.

Press the **▼** or **▲** buttons until you reach the correct minutes.

Press the **TIME** button again. The day or the week will begin to blink.

Press the **▼** or **▲** buttons until you reach the correct day of the week.

Press the **TIME** button again. The display will now indicate the correct time and day of the week.

3 FILTER TIMER

- A** When in configuration the selections are in months, each month selections are equal to 30 days.
- B** To review the remaining days press the "F" button.
- C** To reset the filter days - press the "F" button (to enter the filter program) and then hold the **▼** and **▲** buttons. This resets the timer and starts counting the days until the next filter change.

MANUAL OPERATION

1 HOLD TEMPERATURE

With the **SYSTEM** switch set to **HEAT** or **COOL**, momentarily press the **HOLD** button **HOLD** will be displayed. Use the **▼** or **▲** buttons to adjust the temperature.

The thermostat will control the room temperature at the selected setting until you press the **RUN** button to restart the program operation.

2 TEMPERATURE OVERRIDE (WHEN IN THE PROGRAM RUN MODE)

Press the **▼** and **▲** buttons to select the desired room temperature. The thermostat will override the current programming and keep the room temperature at the selected temperature until the next program period begins. The thermostat will then revert back to the program temperatures.

PLANNING YOUR PROGRAM

NOTE: The time of day clock **MUST** be set to the correct day and time in order for the programmed times to be correct.

Look at the factory preprogrammed times and temperatures shown in the Factory default program setting. If this program will suit your needs, simply press the **RUN** button to begin running the factory preset program.

If you wish to change the preprogrammed time and temperature, follow these steps:

Determine the time periods and temperatures for your program. You must program four periods for each day. However, you may use the same heating and cooling temperatures for consecutive time periods. You can choose heating temperature, cooling temperature and start time independently. (for example, you may select 5:00 am AND 70° F as the weekday first period heating start time and temperature and also choose 7:00 AM and 76°F as the weekday first period cooling start time and temperature.

Use the table below to plan your program time periods and the temperatures you want during each period. Fill in the completed table to have a record of your program.

Example:

Heating / Cooling Schedule Plan (Factory default program setting)

		weekdays (5days)		Saturday & Sunday	
Mode	Period	Start Time	Temperature	Start Time	Temperature
Heat	1st	6:00 AM	70°F	6:00 AM	70°F
	2nd	8:00 AM	62°F	8:00 AM	62°F
	3rd	6:00 PM	70°F	6:00 PM	70°F
	4th	10:00 PM	62°F	10:00 PM	62°F
Cool	1st	6:00 AM	75°F	6:00 AM	75°F
	2nd	8:00 AM	83°F	8:00 AM	83°F
	3rd	6:00 PM	75°F	6:00 PM	75°F
	4th	10:00 PM	78°F	10:00 PM	78°F

Plan your Program Setting Heating / Cooling

		weekdays (5days)		Saturday & Sunday	
Mode	Period	Start Time	Temperature	Start Time	Temperature
Heat	1st				
	2nd				
	3rd				
	4th				
Cool	1st				
	2nd				
	3rd				
	4th				

ENTER THE HEATING PROGRAM

- 1 Move the **SYSTEM** switch to the **HEAT** position
- 2 Press **PRGM** once. **PRGM SETTING** will display, and "MON TUE WED THU FRI" (indicating weekday program) will appear in the display (flashing). Also displayed are the current programmed start time for the first heating period (flashing), and the currently programmed temperature.
- 3 Press the **↓** and **↑** buttons to select the desired first heating period start time. The time will change in 15 minute increments. When your selected time is displayed, press the **TIME** button to change to the temperature mode.
- 4 Press the **↓** and **↑** buttons to select the desired first heating period temperature.
- 5 Press **PRGM** once. The currently programmed start time and set point for the 2nd heating program will appear.
- 6 Repeat steps 3 and 4 to select the start time and heating temperature for the 2nd heating program period.
- 7 Repeat steps 3 thru 5 for the 3rd and 4th heating program periods.
- 8 Press **PRGM** once. **PRGM SETTING** will display, and "SAT SUN" indicating weekday program) will appear in the display (flashing). Also displayed are the current programmed start time for the 1st heating period (flashing), and the currently programmed temperature.
- 9 Repeat steps 3 thru 7 to complete Saturday and Sunday programming.
- 10 When you have completed entering your heating program, press **RUN**.

ENTER THE COOLING PROGRAM

Caution: If the outside temperature is below 50°F / 10°C; disconnect power to the cooling system before programming. Energizing the air conditioner compressor during cold weather may cause property damage.

- 1 Move the **SYSTEM** switch to the **COOL** position.
- 2 Follow "Enter the Heating Program" for entering your cooling program, using your selected cooling times and temperatures.

CHECK YOUR PROGRAMMING

Follow these steps to check your thermostat programming one final time before beginning thermostat operation:

- 1 Move the **SYSTEM** switch to the **HEAT** position
- 2 Press **PRGM** to view the 1st weekday heating period time and temperature.
Each time you press **PRGM** the next heating period time and temperature will be displayed in sequence for weekday, then Saturday and Sunday program periods (you may change any time or temperature during this procedure).
- 3 Press **RUN**.
- 4 Move the **SYSTEM** switch to **COOL**
- 5 Repeat step 2 to check the cooling program.
- 6 Move the **SYSTEM** switch to **HEAT** or **COOL** and press **RUN** to begin program operation.

REVERT TO FACTORY DEFAULT PROGRAM SETTINGS

Press the **RESET** button. All user's changed settings will revert to factory default settings (Including configuration settings).

THERMOSTAT BUTTONS AND SWITCHES

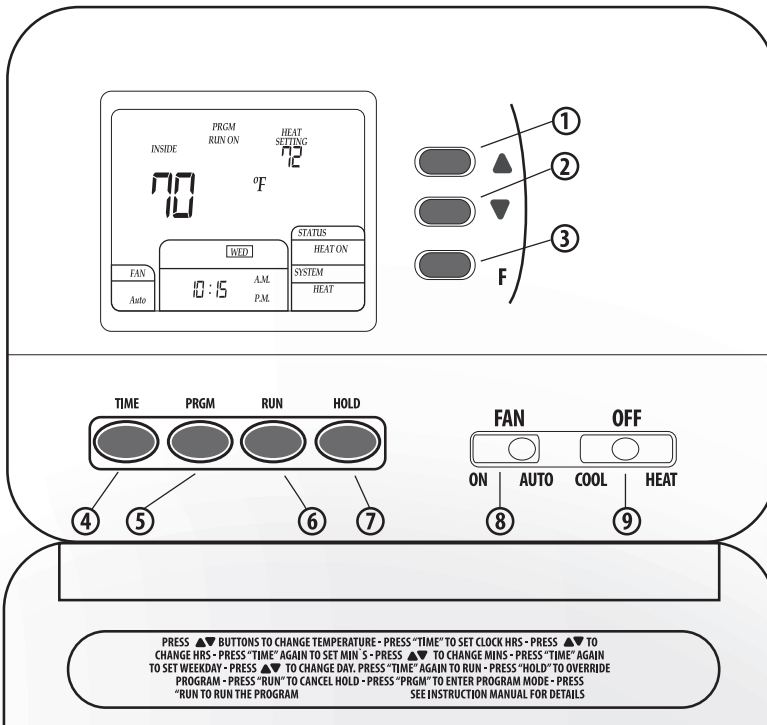

- (1) And (2) Raises or lowers the temperature setting and selects option in the configuration menu.
- (3) Inquiry button for count back time of filter alarm.
- (4) Time set button.
- (5) Program set button.
- (6) Program **RUN** button.
- (7) Temperature **HOLD** button.
- (8) Fan Control Switch (**AUTO/ON.**)
- (9) System Control Switch (**COOU OFF/HEAT.**)

THERMOSTAT LCD DISPLAY

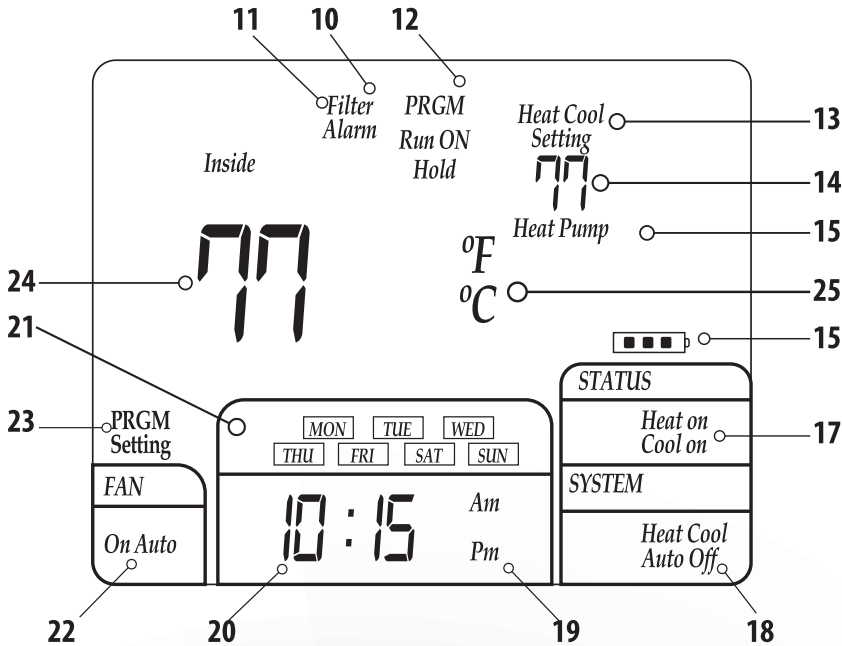

- (10) Filter Alarm: Indicates filter needs to be replaced.
- (11) Alarm not used in this model.
- (12) **PRGM Run On:** Indicates when the thermostat is in the program **RUN** mode. **HOLD** Indicates when the thermostat is in the temperature **HOLD** mode.
- (13) **Heat Setting.** Temperature set-point in the Heating Mode
Cool Setting Temperature set-point in the Cooling Mode
- (14) Set-point temperature display
- (15) Indicates thermostat is calling for heat in the **HEAT PUMP** mode
- (16) **Battery Icon:** If the Battery Icon is flashing, batteries need to be replaced.
 Note: It may take up to 30 seconds for the low battery icon to disappear after changing batteries.
- (17) Indicates the thermostat is calling for **HEAT** or **COOL**
- (18) Indicates the current system switch position.
- (19) Clock **AM/PM** indicator
- (20) Indicates the current time of day or days, being programmed.
- (21) Indicates the current day or days being programmed.
- (22) Indicates the current fan switch position
- (23) Indicates when the thermostat is in the **PRGM** mode.
- (24) Indicates the current actual room temperature, or the current configuration menu number.
- (25) Indicates whether the displayed temperature is in °F or °C

TROUBLESHOOTING

Symptom	Possible Cause	Corrective Action
No heat No Cool No Fan	<ol style="list-style-type: none"> 1. Blown fuse or tripped circuit breaker 2. Furnace power switches to OFF 3. Furnace blower compartment door or panel loose or not properly installed 	Replace fuse or reset breaker Turn switch to ON Replace door panel in proper position to engage safety interlock or door switch.
No heat	<ol style="list-style-type: none"> 1. Pilot light not lit 2. System switch not set to heat 3. Loose connection to thermostat or system 4. Furnace Lockout Condition. Heat may also be intermittent 5. Heating System Requires service or thermostat requires replacement 	Relight Pilot Set System Switch to heat and raise set point above room temperature Verify thermostat and system wires are securely attached Many furnaces have safety devices that shut the system down when lockout condition occurs. If the heat work intermittently, contact the furnace manufacturer or local service person for assistance. Diagnostic: Set system Switch to Heat and raise the Setpoint above room temperature. Within a few seconds the thermostat should make a soft click sound. This sound usually indicates the thermostat is working properly. If the thermostat does not click, try the reset operation listed above. If the thermostat does not click after being reset, contact the furnace manufacturer or a service person to verify the heating system is operating correctly
No Cool	<ol style="list-style-type: none"> 1. System Switch not set to cool 2. Loose Connection to thermostat or system 3. Compressor lock-out is activated. 	Set System switch to cool and lower set point below room temperature. Verify thermostat and system wires are securely attached. Wait five minutes until the compressor protection time is up. There may be up to a five minute delay before the thermostat can activate the compressor if the compressor lock-out option is selected in the configuration menu.
Heat, Cool or fan runs constantly	<ol style="list-style-type: none"> 1. Fan switch set to FAN ON 2. Possible short in wiring 3. Possible short in thermostat 4. Possible short in Heat/Cool/Fan system 	Check each wire connection to verify they are not shorted or touching together. No bare wires should stick out from under terminal screws. Try resetting the thermostat as described below. If the condition persists, the manufacturer of your system or service person can instruct you on how to test the Heat/Cool system for correct operation. If the system operates correctly, replace the thermostat.
Furnace cycle too fast or too slow	<ol style="list-style-type: none"> 1. The location of thermostat and/or the size of the heating system may be influencing the cycle rate. 	Item 2 in the Configuration Menu is the adjustment that controls the heating cycle rate. If an acceptable cycle rate is not achieved using the FA or SL adjustment, contact a local service person for additional suggestions.
Cooling cycles too fast or too slow	<ol style="list-style-type: none"> 1. The location of thermostat and/or the size of the heating system may be influencing the cycle rate. 	Item 1 in the Configuration Menu is the adjustment that controls the cooling cycle rate. If an acceptable cycle rate is not achieved using the FA or SL adjustment, contact a local service person for additional suggestions.
Thermostat setting and thermometer	<ol style="list-style-type: none"> 1. Thermostat thermometer setting requires adjustment. 	The thermostat temperature calibration can be adjusted +/- 3 degrees as listed in item 7 of the Configuration menu. No other adjustment is possible.
Clock loses or gain time	<ol style="list-style-type: none"> 1. Loss of power to thermostat and low batteries 	The thermostat will maintain its program in memory even with no power and no batteries, but the clock time will be incorrect when power is restored. See No Heat/No Cool/No Fan above for items to check in the system.

Symptom	Possible Cause	Corrective Action
Thermostat does not follow program	1. AM or PM set incorrectly in program 2. AM or PM set incorrectly on the clock 3. Voltage spike or static discharge	Check current clock and program setting including the AM or PM designation for each time period. If a voltage spike or static discharge occurs, use the Reset Operation listed above.
Blank display and/or keypad not responding	1. Loss of power and dead batteries. 2. Voltage spike or static discharge	Replace batteries and check heat/cool system for proper operation. If a voltage spike or static discharge occurs, use the reset operation listed above.

If a voltage spike or static discharge blanks out the display or causes erratic thermostat operation, you can reset the thermostat by pressing the reset button (See Figure 1). If the thermostat has power, and has been reset; and still does not function correctly, contact your heating/cooling service contractor.

WARRANTY POLICY

WARRANTS THE FOLLOWING:

Only cataloged products sold to distributors are warranted to the original purchaser, and to be free from defects in material and workmanship, for a period of one (1) year from the date of purchase, unless specified in writing for a different period. Prior to returning this product to us, the purchaser shall give us notice in writing stating how this product fails to fulfill this warranty. No product shall be accepted for repair or replacement without a required written notice and without prior written authorization and shipping address having been received by the purchaser. Only our factory is authorized to perform services under this warranty.

Transportation charges are to be prepaid by the purchaser.

This warranty does not extend to any product that has been subjected to misuse, abuse, neglect, accidents, alternations, improper installation or use in violation of the printed instructions furnished by us. This warranty neither applies to batteries not deterioration of nor damage to the product caused by the use of faulty batteries.

WE SHALL, NOT IN ANY EVENT BE LIABLE FOR ANY INCIDENTAL OR CONSEQUENTIAL DAMAGES. This warranty gives you specific legal rights, and you also have other rights which vary from state to state. Some states do not allow the exclusion or limitation of incidental or consequential damages, or implied warranties, so the above limitations or exclusion may not apply to you.